

Innenansicht
View from the Inside

- ① erstöffnend / primary panel
- ② zweitöffnend / secondary panel

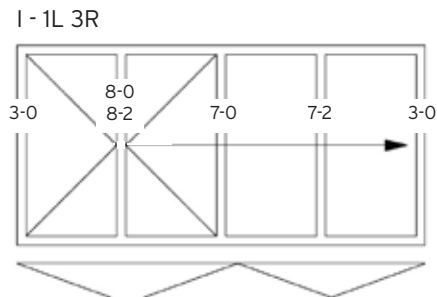
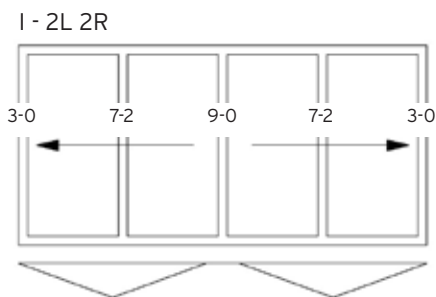
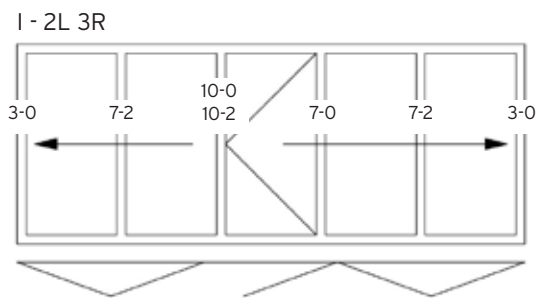
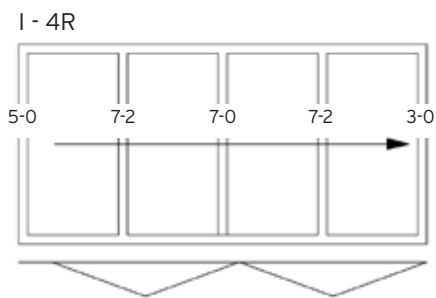
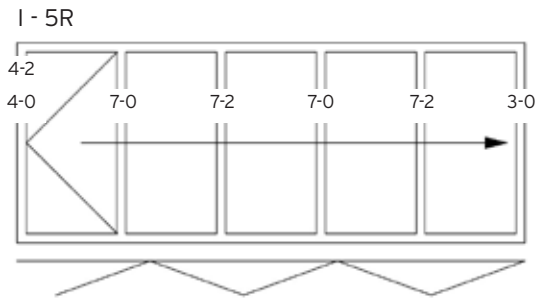
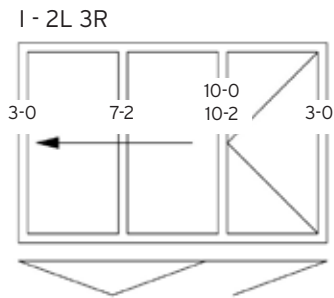
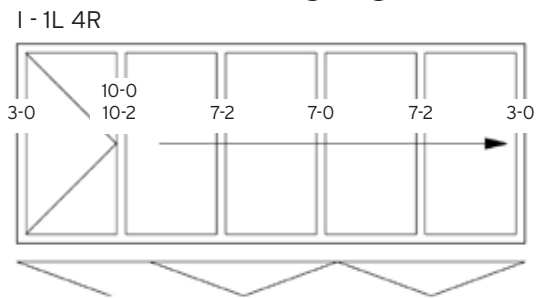
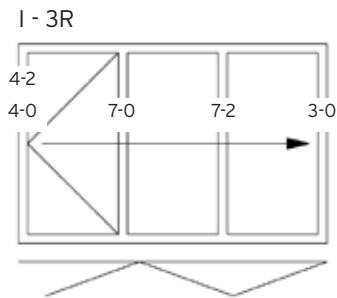
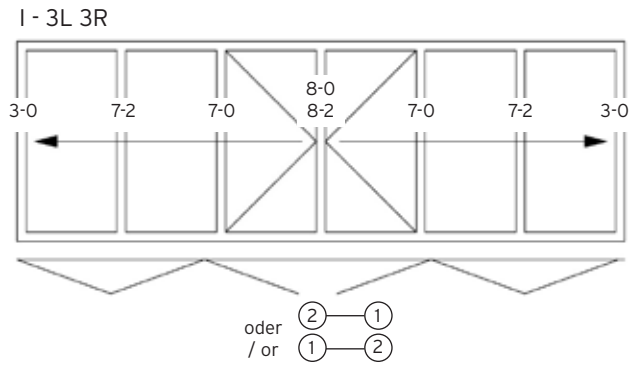
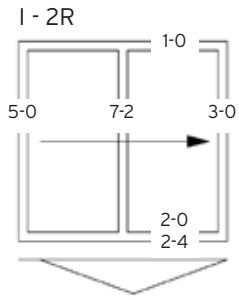

oder / or ②-① / ①-②

oder / or ②-① / ①-②

Innenansicht
View from the Inside

- ① erstöffnend / primary panel
- ② zweitöffnend / secondary panel

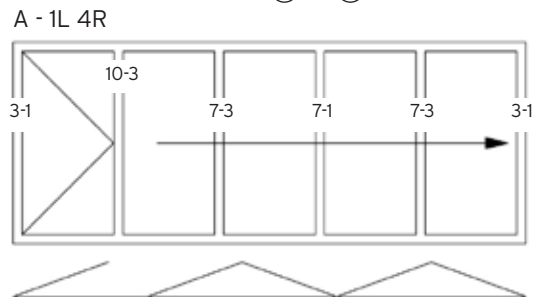
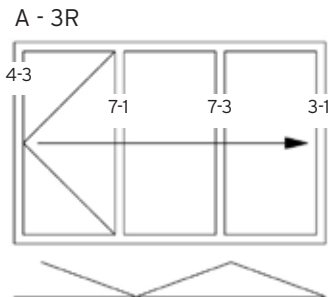
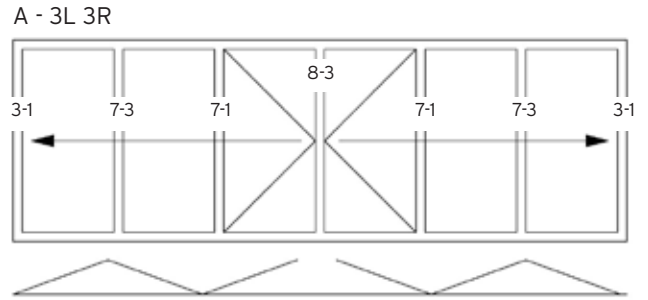
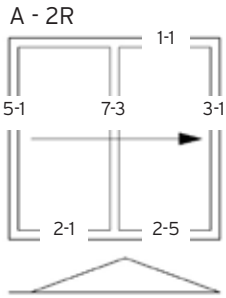

oder / or

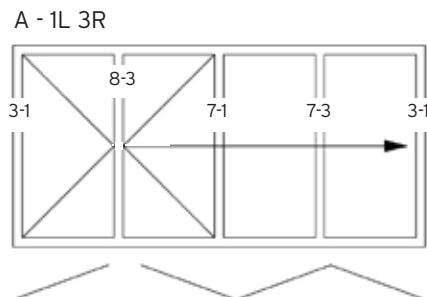
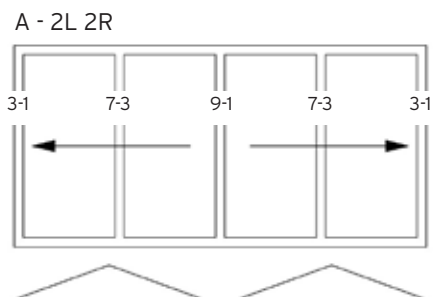
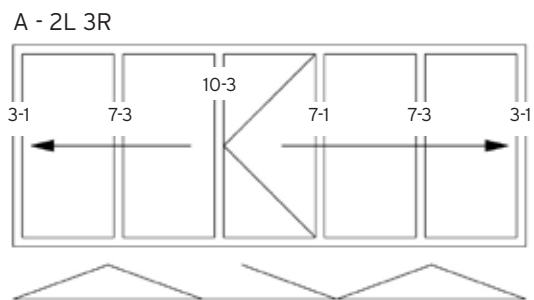
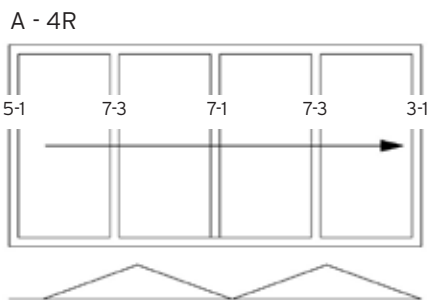
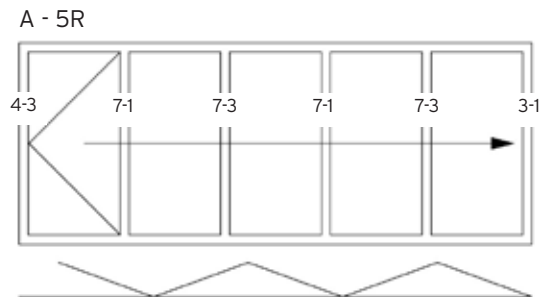
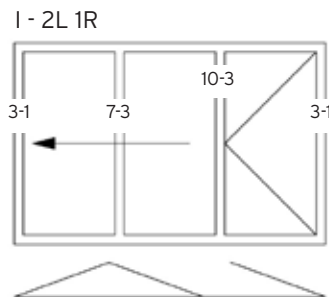

oder / or

oder / or

Innenansicht
View from the Inside

- ① erstöfnend / primary panel
- ② zweitöfnend / secondary panel

Faltwand mit Drehkipplügel im Faltflügel.
 Folding façade with tilt and turn panel integrated in folding panel.

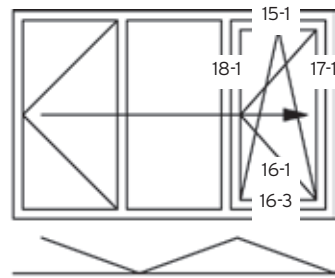
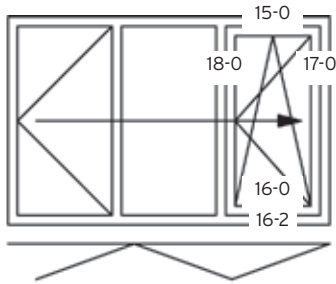

Faltwand mit Sprosse.
 Folding façade with transom.

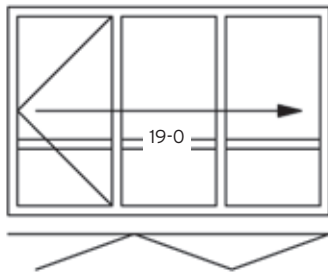

Faltwand mit Oberlicht.
 Folding façade with overhead panel.

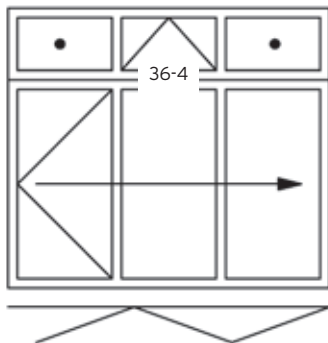

Faltwand auf Brüstung.
 Folding façade on parapet.

